



Model 1-580

**SERVICE MANUAL**

# 1-580 Circuit Description

## GENERAL

The 1-580 is designed around a double-sided P.C. board that comprises Royce's "semi-leadless" chassis. A unique feature of the 1-580 is the remote control of the main chassis by means of the full-function control head and microphone. The main board circuitry consists of the r.f. and i.f. stages, audio, transmitter modulator and output stages. The control head consists of the S/RF meter, controls, speaker and ext. jacks (except R.F.). The microphone initiates the channel change function and contains the channel readout. In addition there is one "modular" board in the main chassis, the crystal oscillator unit, which will be examined further subsequently.

## R.F. SECTION

Incoming r.f. signals from the antenna jack are applied through T101 to the base of Q101 (2SC674). The input is diode protected against transients. The output of Q101 is applied to the base of the first mixer Q102 (2SC710) as is the 37 MHz output from the crystal oscillator unit (pin 13). The mixing process provides the first i. f. frequency output (10.7 MHz) which, after passing through the 10.7 MHz filter (F101), is applied to the input of the second mixer 2SC711 (Q103). The crystal oscillator unit also provides an output of 10.1 MHz to the input of Q103. The mixing process then completes conversion to the 455KHz second i. f. which is then applied to the 455 KHz i. f. filters (F102, F103).

A high degree of selectivity is achieved through the use of the dual i. f. filters, hence no tuned circuits are utilized in the three-stage i. f. strip consisting of 2SC711 (Q104, Q105), 2SA562 (Q106). The output of the detector 1S188 (D102) is then applied through a noise gate (ANL function) to provide audio output to the volume control.

## AUDIO SECTION

The audio signal from the volume control is applied to the first audio preamp 2SC372 (Q109). Providing the squelch is "off," the output of Q109 is applied to a second audio preamp 2SC735 (Q301). The output of Q301 feeds the audio driver I. C. TA7062P (Q302) which in turn drives the primary of driver transformer ETT-1001(T2). The output is a push-pull stage consisting of T2 secondary, the audio output (and modulator) transistors 2SD330 (Q303, Q304), and the modulation and output transformer ETT-20015 (T1). In the receive mode, the audio output secondary of T1 drives the speaker via the switching relay NS2-P-DC12V (RL 1-2).

## MODULATOR SECTION

The modulator section begins at the microphone input jack. In the transmit mode (pin 3 grounded at mic jack), the switching relay will be activated. The audio input (pin 1 mic jack) is applied to the base of the mic preamp 2SC372 (Q205). The signal then follows a similar progression from Q301 on through to the output as outlined in the AUDIO SECTION, preceding with two exceptions. The audio output winding is disconnected, and the output of the modulation transformer is applied to the transmitter driver and output stages. A negative feedback signal is developed by the "automatic modulation control" circuit from the modulation stage output. Modulation peaks in the output cause A.M.C. amplifier 2SB561 (Q204) to conduct, thus limiting the audio input level. Threshold of the circuit is controlled by the 10 K ohm mini-potentiometer VR201.

## TRANSMITTER SECTION

The transmitter section is conventional and straightforward in design. The crystal oscillator unit provides a 27 MHz signal to the input of the predriver 2SC710 (Q201). Class A operation is employed in the Q201 drives the r. f. driver 2SC1018 (Q202) which in turn drives the r. f. final 2SC756 (Q203). Both the driver and final are operated class B. The output circuitry comprises a pi-loading, and low pass filter network. Associated circuitry consists of a tap on the r. f. output, rectified by D201 (1S188) to provide a signal for the r. f. meter, and the transmit-modulation indicator amplifier 2SC735 (Q206).

## SQUELCH — A.G.C.

The A.G.C. amplifier 2SC372 (Q108) operates on signals supplied by the detector output. The A.G.C. output is applied to the base of Q102 and Q104. The A.G.C. output also serves as a source for the squelch circuit transistor 2SC372 (Q107) which, when operational, biases Q109 off.

1-580

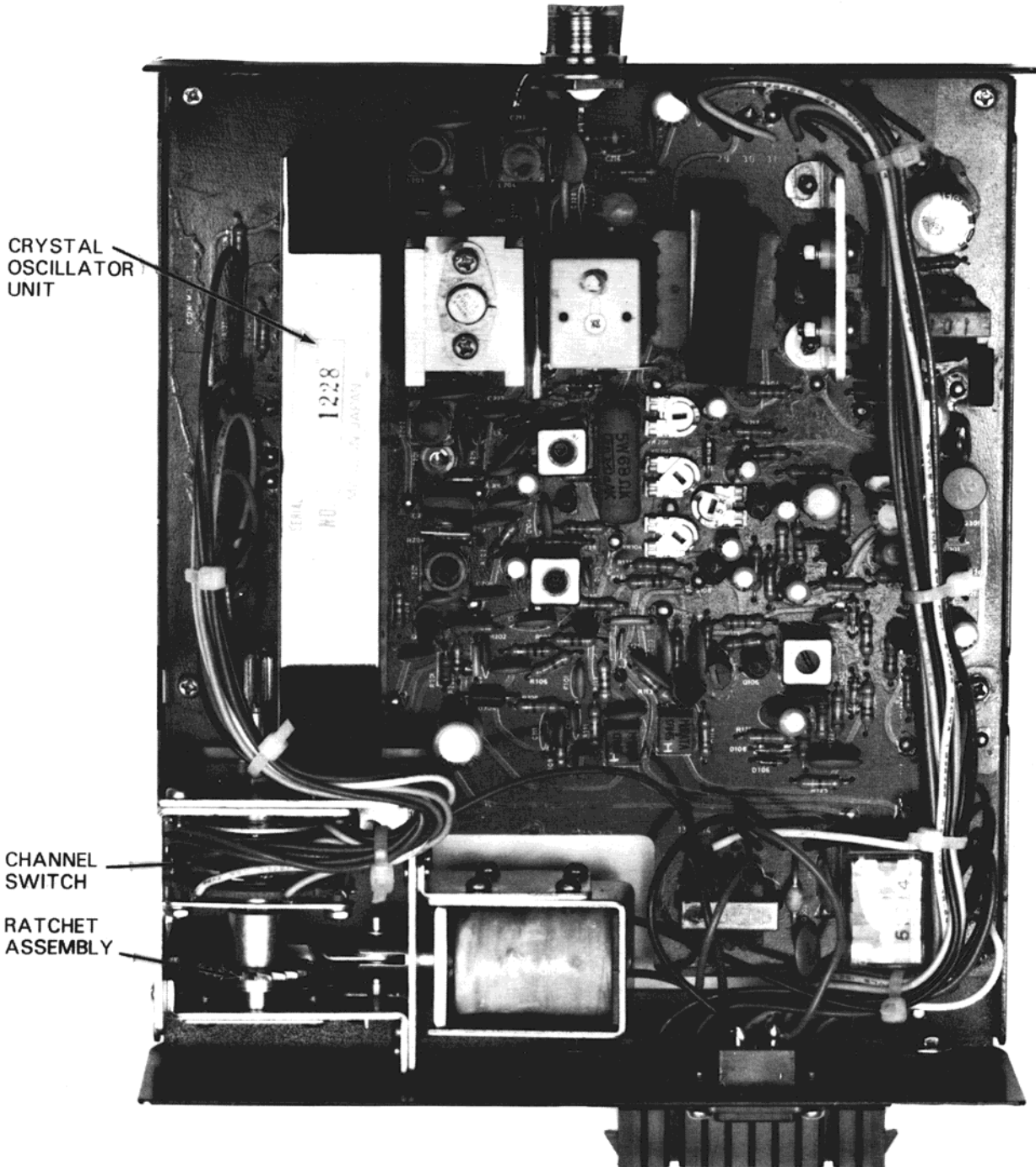

FIG 1

1-580

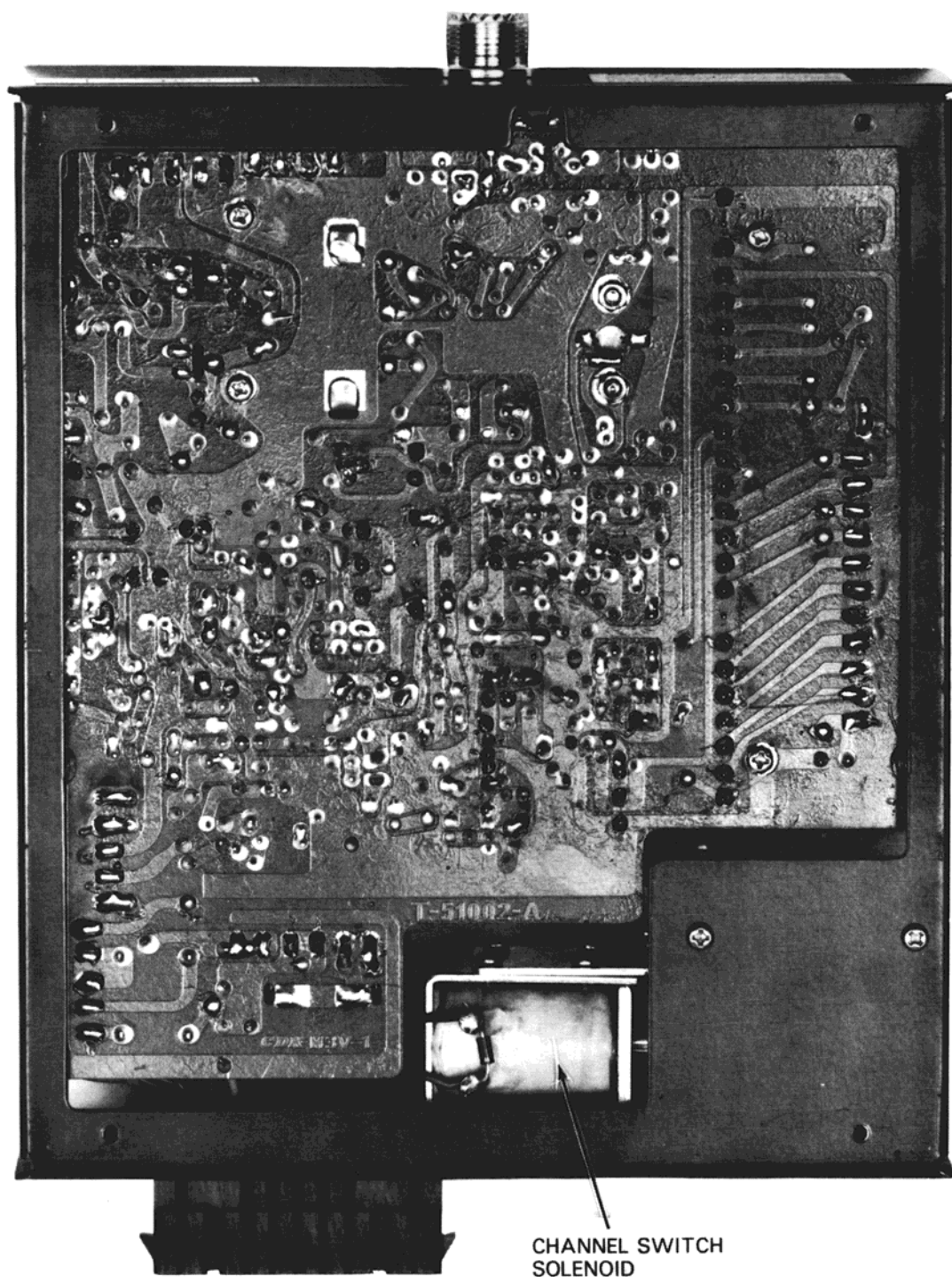
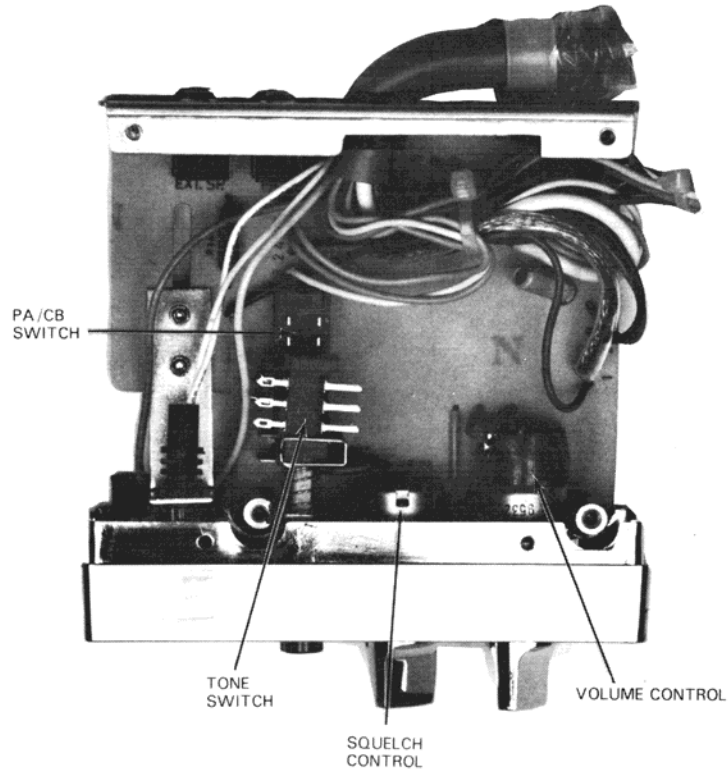

FIG 2

# 1-580 CONTROL HEAD

TOP VIEW



BOTTOM VIEW

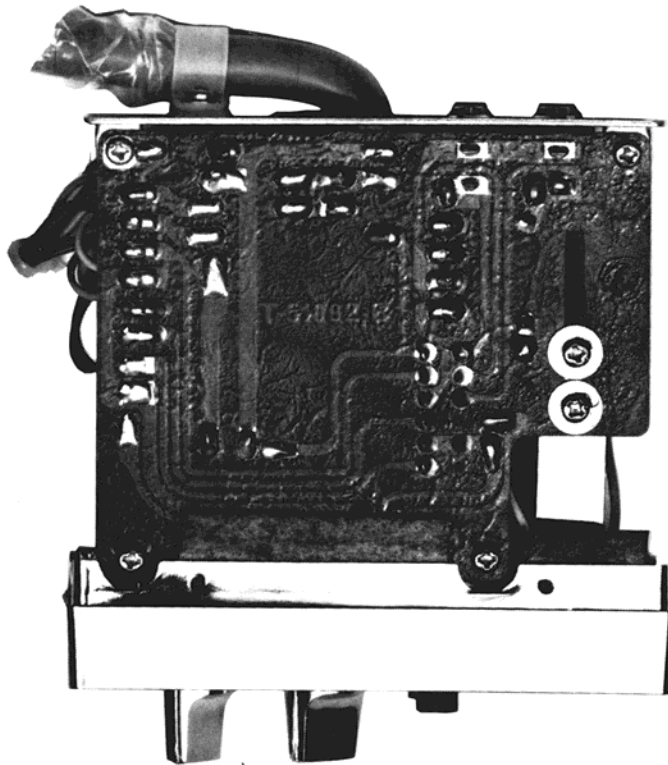
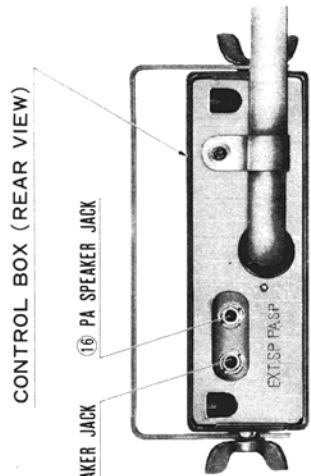
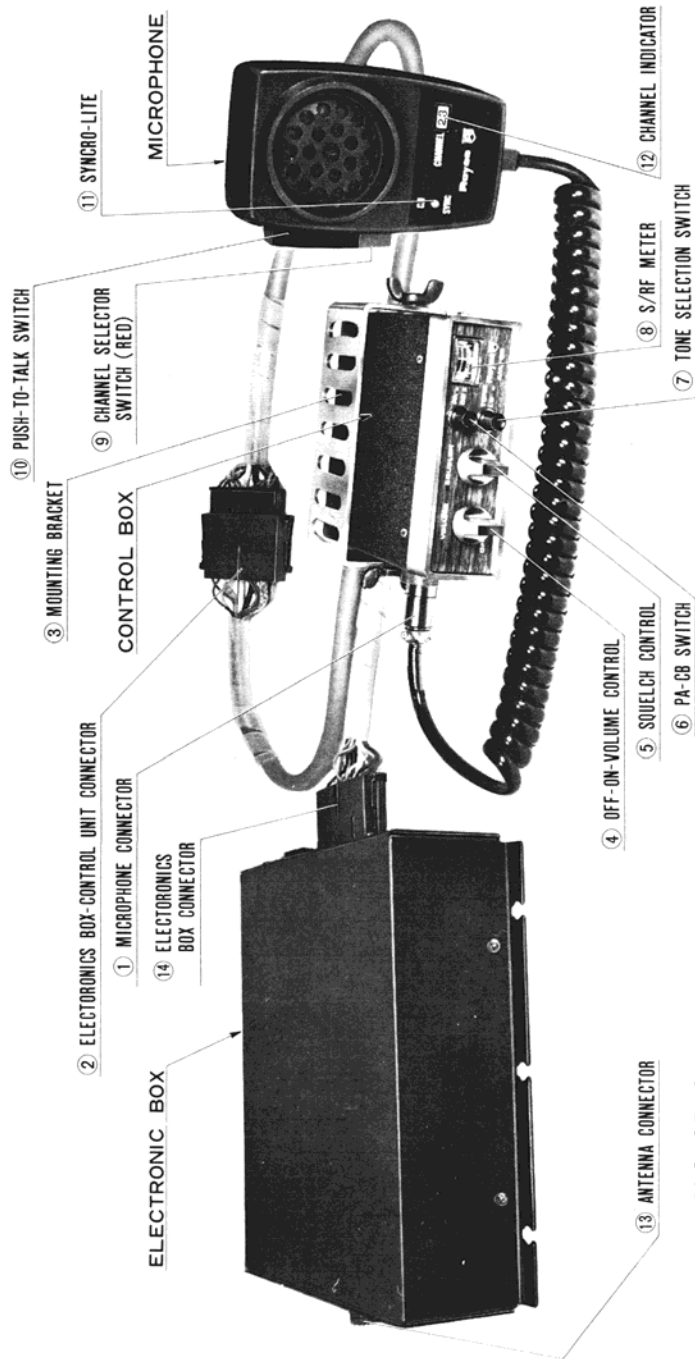

Fig 3



1 MICROPHONE CONNECTOR

2 ELECTRONICS BOX CONNECTOR

3 MOUNTING BRACKET

4 OFF-ON-VOLUME CONTROL

5 SQUELCH CONTROL

6 PA-CB SWITCH

7 TONE SELECTION SWITCH

8 S/RF METER

9 CHANNEL SELECTOR SWITCH (RED)

10 PUSH-TO-TALK SWITCH

11 SYNCRO-LITE

12 CHANNEL INDICATOR

13 ANTENNA CONNECTOR

14 ELECTRONICS BOX CONNECTOR

15 EXTERNAL SPEAKER JACK

16 PA SPEAKER JACK

**ELECTRONIC BOX**

- (1) MICROPHONE CONNECTOR
- (2) ELECTRONICS BOX-CONTROL UNIT CONNECTOR
- (3) MOUNTING BRACKET
- (4) OFF-ON-VOLUME CONTROL
- (5) SQUELCH CONTROL
- (6) PA-CB SWITCH
- (7) TONE SELECTION SWITCH
- (8) S/RF METER

**MICROPHONE**

- (9) CHANNEL SELECTOR SWITCH (RED)
- (10) PUSH-TO-TALK SWITCH
- (11) SYNCRO-LITE
- (12) CHANNEL INDICATOR

**CONTROL BOX**

- (1) MICROPHONE CONNECTOR
- (2) ELECTRONICS BOX-CONTROL UNIT CONNECTOR
- (3) MOUNTING BRACKET
- (4) OFF-ON-VOLUME CONTROL
- (5) SQUELCH CONTROL
- (6) PA-CB SWITCH
- (7) TONE SELECTION SWITCH
- (8) S/RF METER

**CONTROL BOX (REAR VIEW)**

- (15) EXTERNAL SPEAKER JACK
- (16) PA SPEAKER JACK

# BLOCK DIAGRAM

1-580

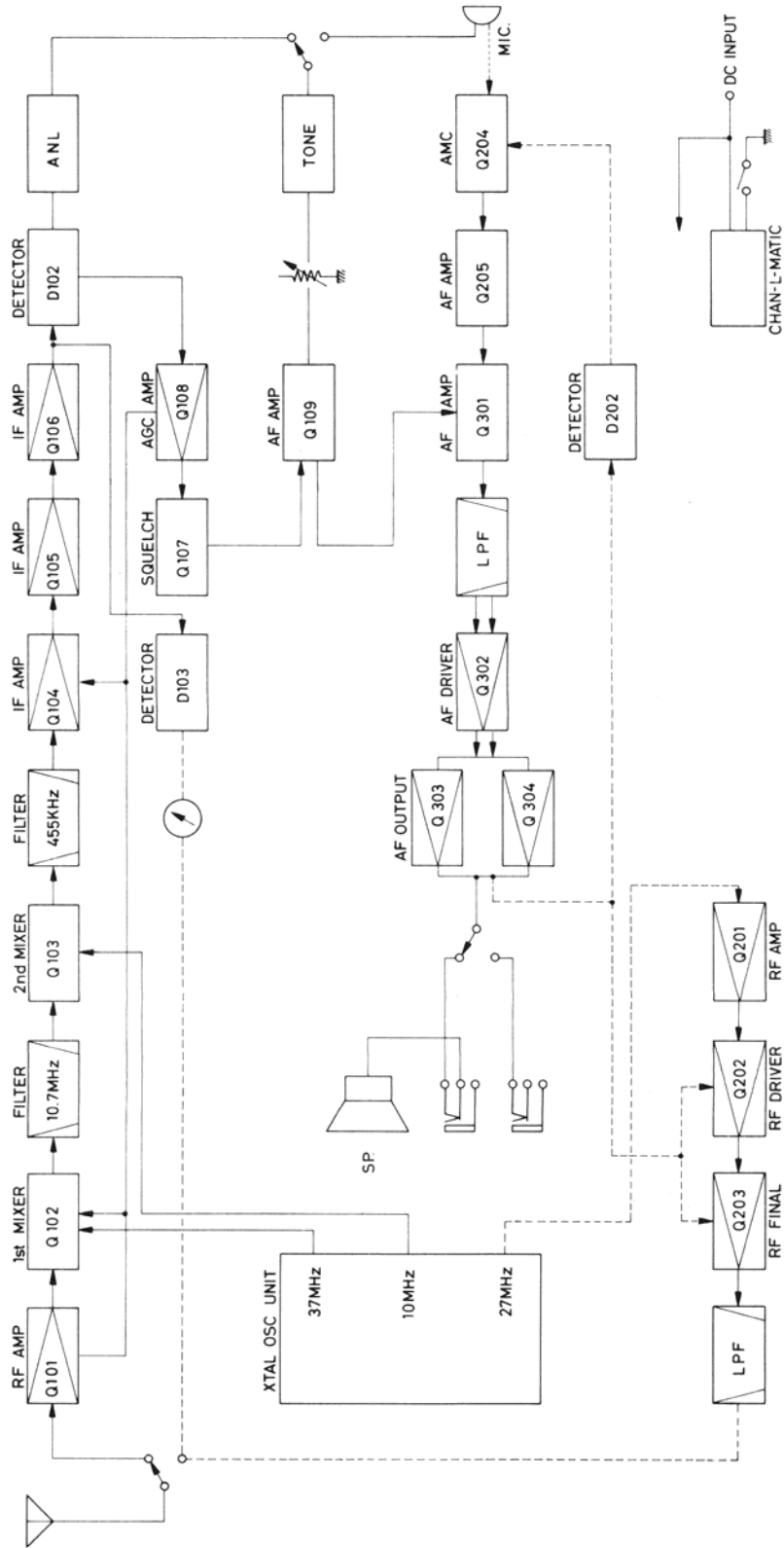

## I-580 Voltage Chart

			<u>RX</u>	<u>TX</u>
Q101	2SC674	Vb	2.6V	
		Vc	6.9V	
		Ve	1.9V	
Q102	2SC710C	Vb	1.1V	
		Vc	8.3V	
		Ve	0.7V	
Q103	2SC711E	Vb	0.6V	
		Vc	4.8V	
		Ve	0V	
Q104	2SC711E	Vb	1.1V	
		Vc	3.0V	
		Ve	0.5V	
Q105	2SC711D	Vb	0.6V	
		Vc	4.7V	
		Ve	0V	
Q106	2SA562Y	Vb	4.7V	
		Vc	0V	
		Ve	5.3V	
Q107	2SC372Y	Vb (NO SQUELCH)	0V	
		(SQUELCH)	0.6V	
		Vc (NO SQUELCH)	7.0V	
		(SQUELCH)	0.1V	
		Ve (NO SQUELCH)	0V	
(SQUELCH)	0V			
Q108	2SC372Y	Vb	2.5V	
		Vc	8.9V	
		Ve	1.8V	
Q109	2SC372Y	Vb (NO SQUELCH)	1.0V	
		(SQUELCH)	0V	
		Vc (NO SQUELCH)	5.8V	
		(SQUELCH)	8.9V	5.0V
		Ve (NO SQUELCH)	0.3V	
(SQUELCH)	0V			

			<u>RX</u>	<u>TX</u>
Q201	2SC710C	Vb	2.1V	1.7V
		Vc	13.7V	13.6V
		Ve	8.9V	1.2V
Q202	2SC1018	Vb		
		Vc	13.5V	12.4V
		Ve		
Q203	2SC756A	Vb		
		Vc	13.5V	12.4V
		Ve		
Q204	2SB561B	Vb		
		Vc		
		Ve		0V
Q205	2SC372Y	Vb	4.1V	4.2V
		Vc	5.8V	4.5V
		Ve	8.9V	3.6V
Q301	2SC735Y	Vb	5.8V	4.5V
		Vc	10.5V	10.7V
		Ve	5.1V	3.9V
Q302	TA7062P	(1)	0.7V	0.7V
		(2)	0.1V	0.1V
		(3)	0V	0V
		(4)	11.6V	11.6V
		(5)	11.0V	11.0V
Q303	2SD330E	Vb	0.6V	0.6V
Q304		Vc	13.7V	13.7V
		Ve	0.1V	0.1V

TOP VIEW 1-580

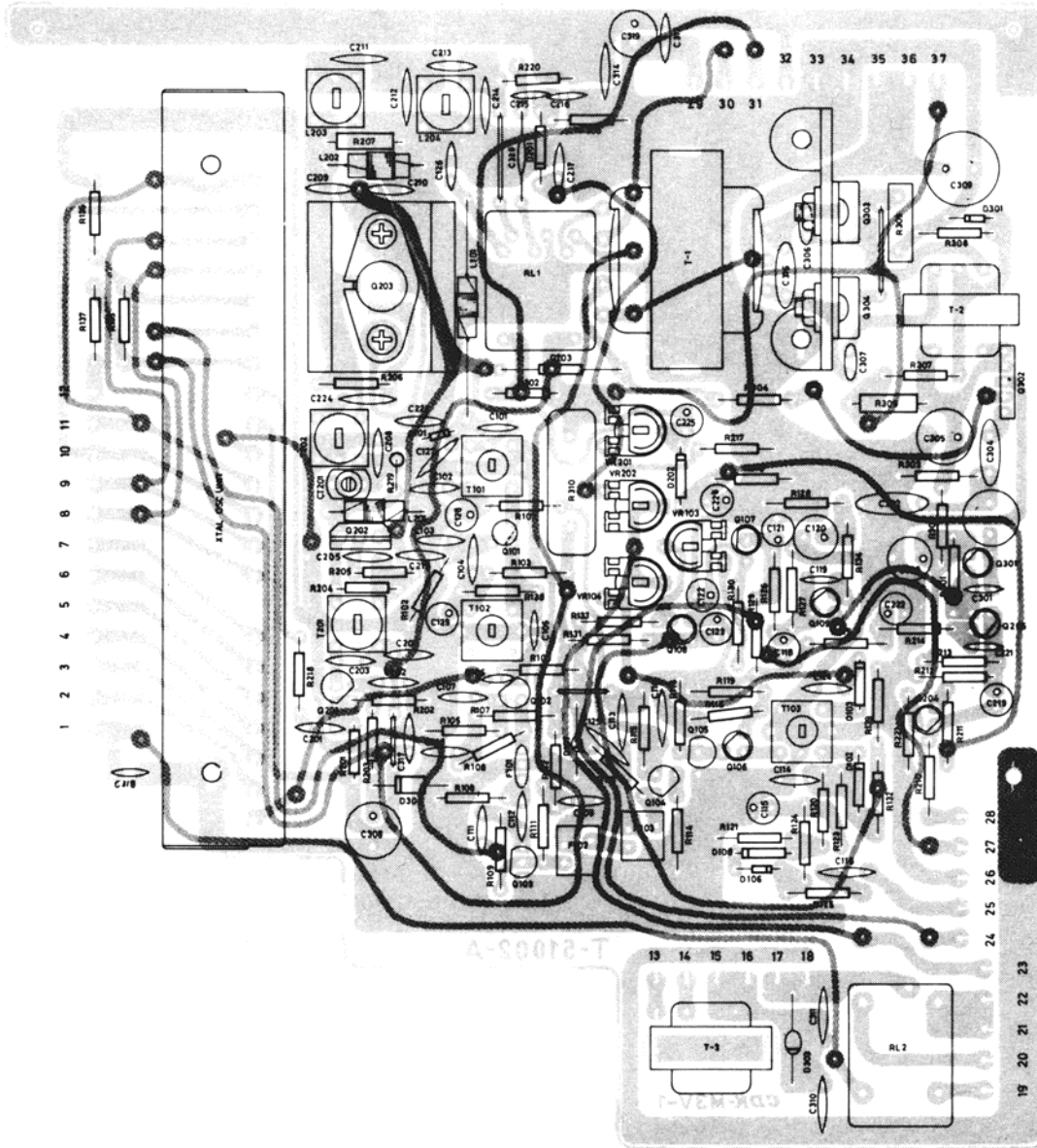

BACK VIEW 1-580

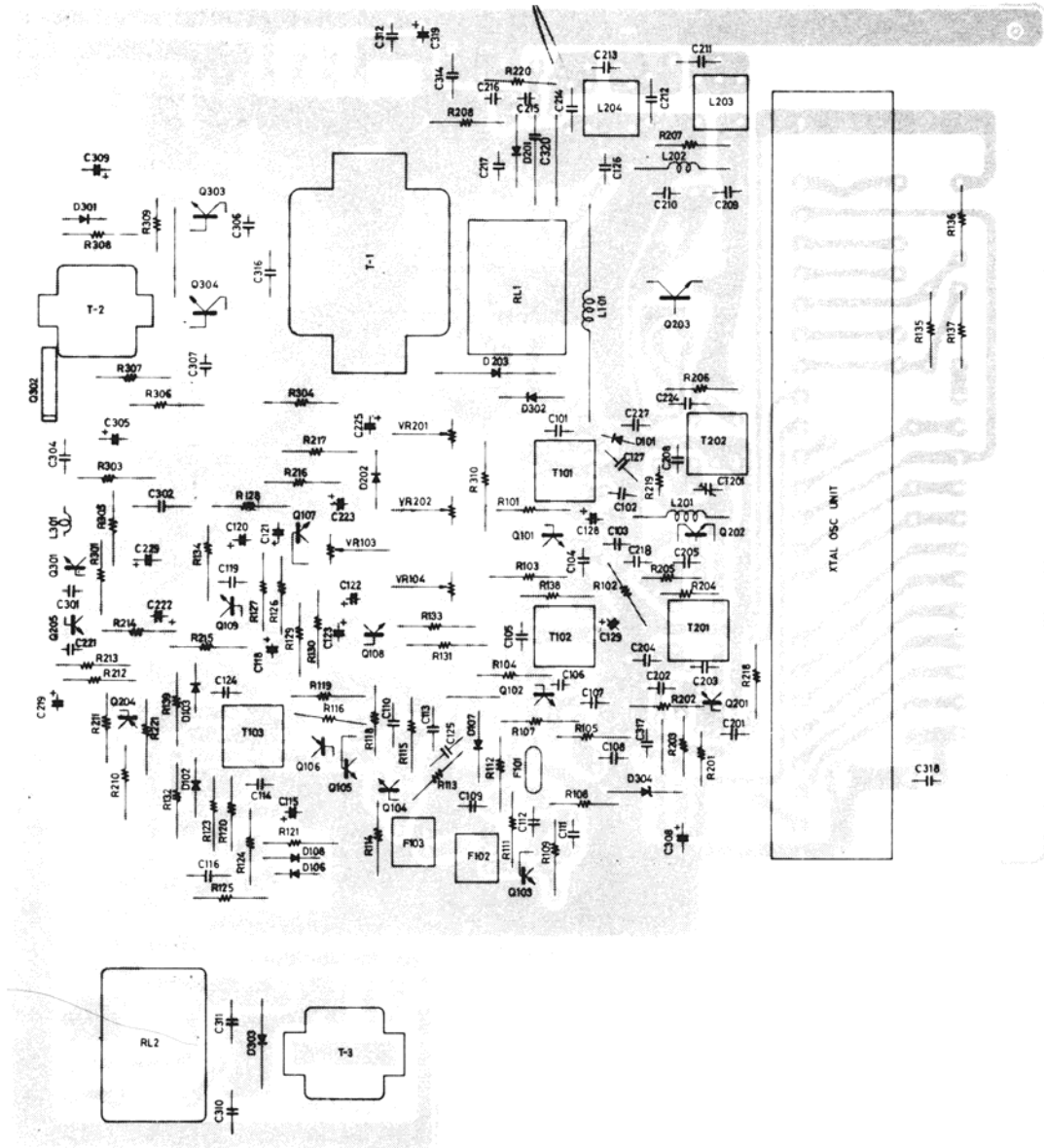

# Crystal Oscillator Unit 2-5065

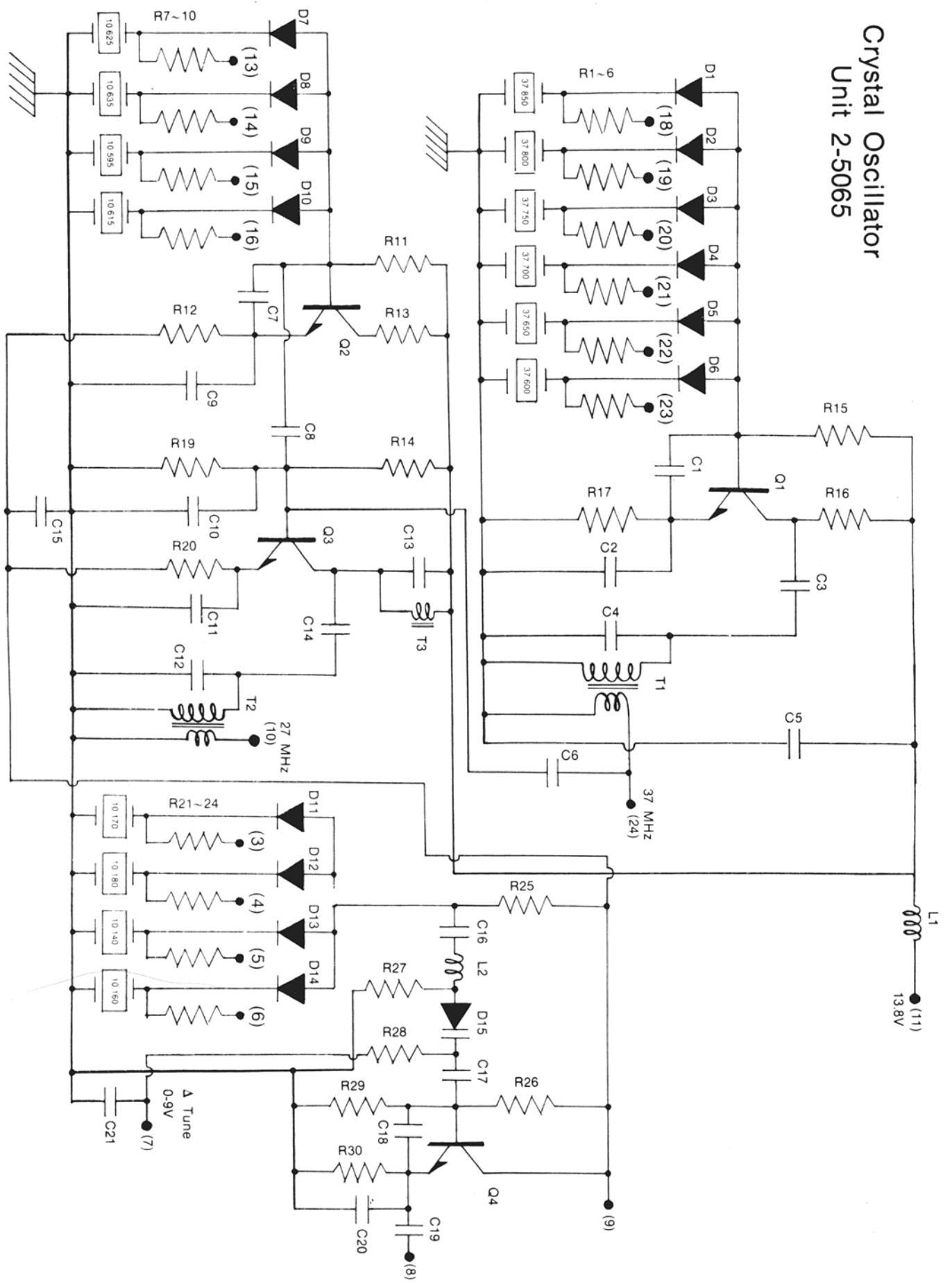

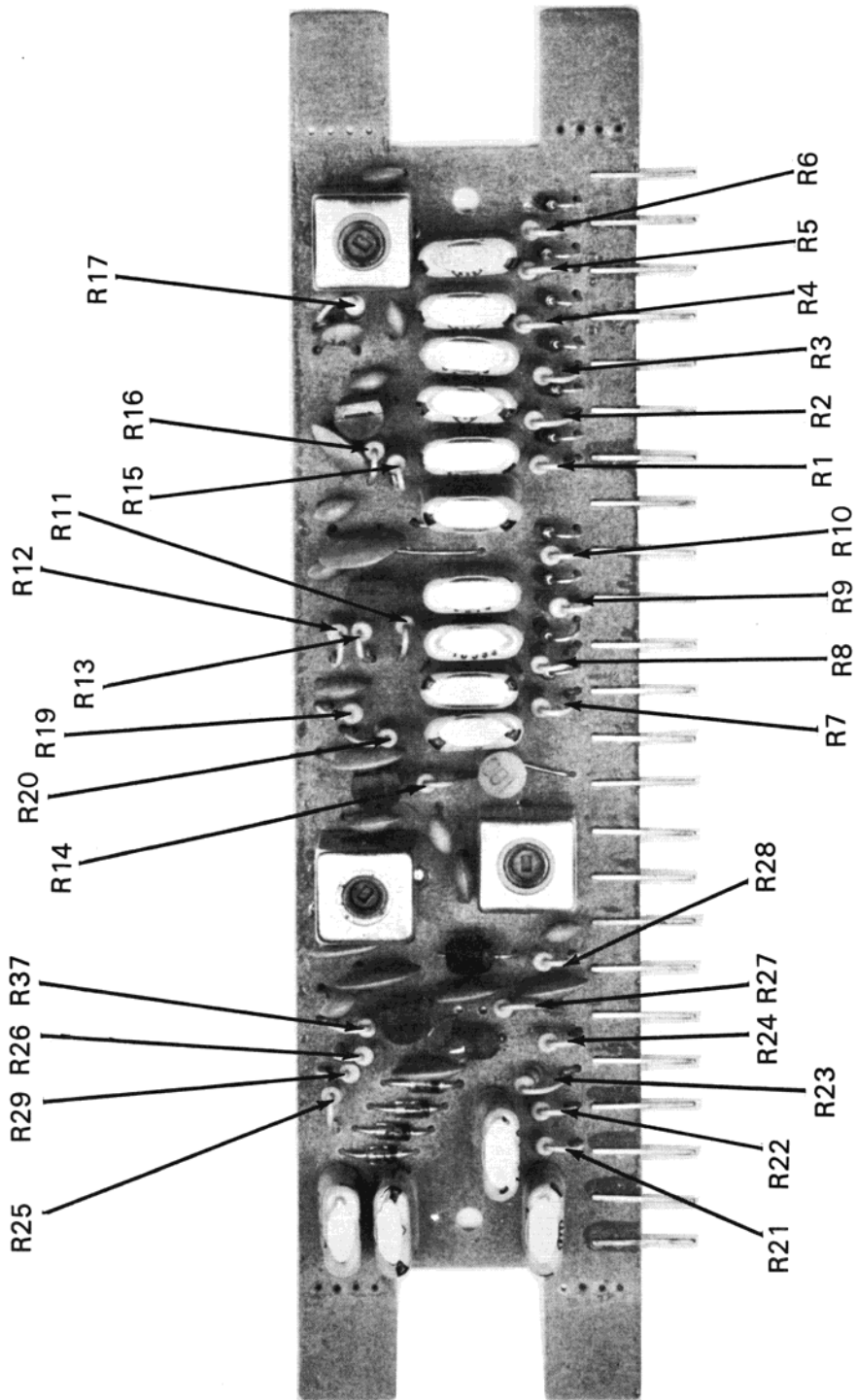

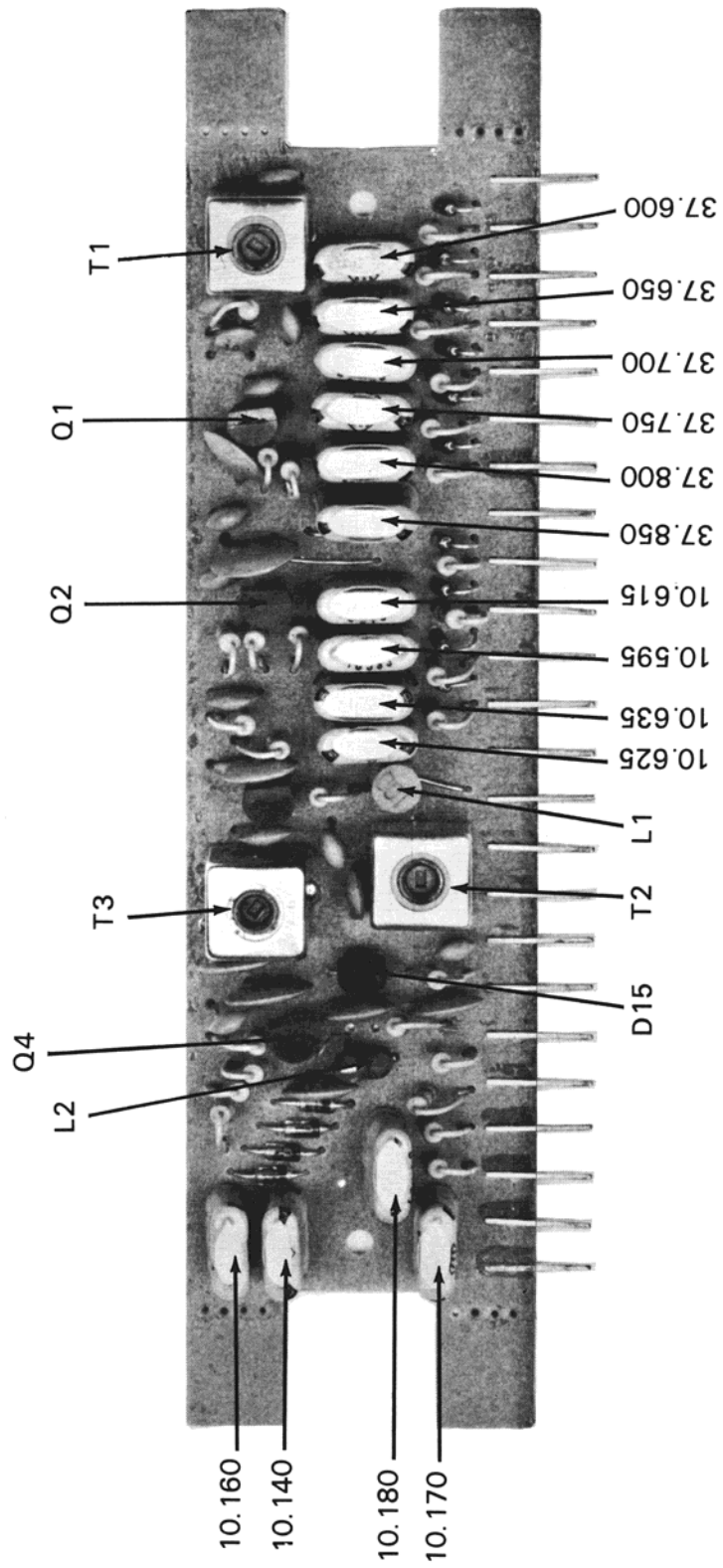

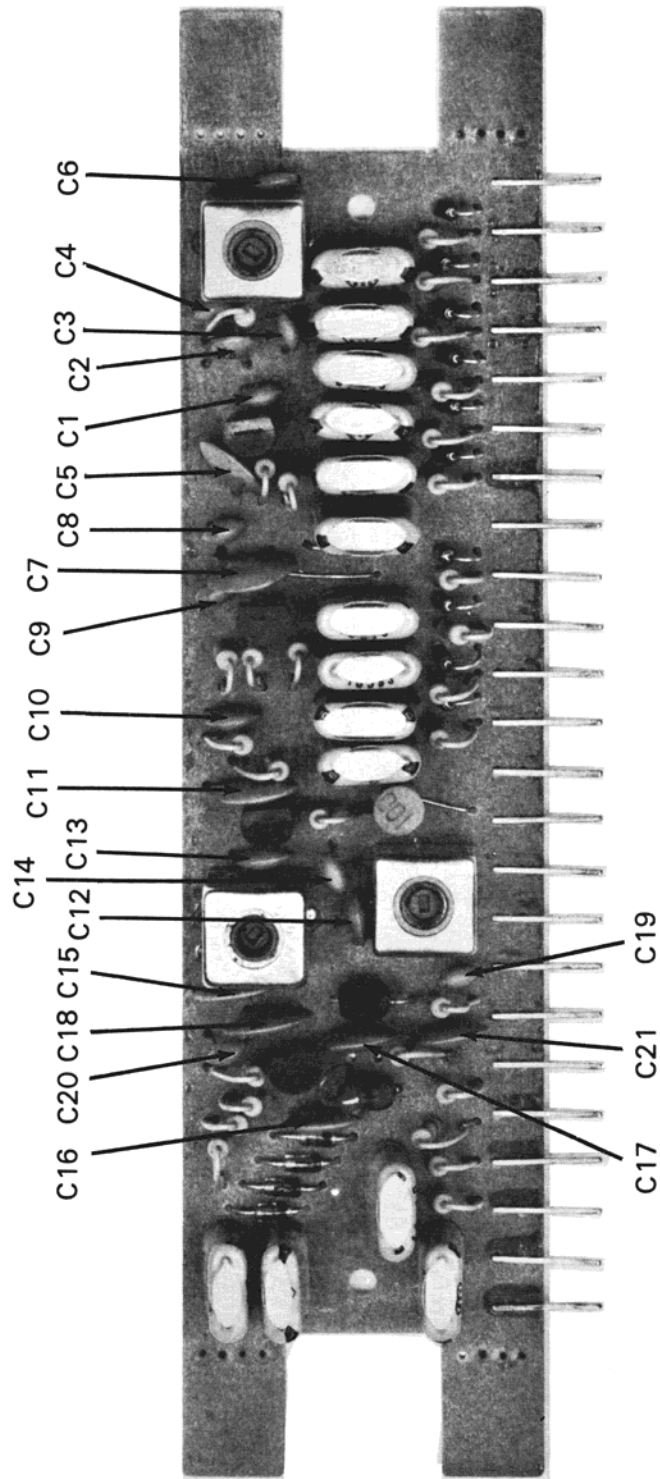

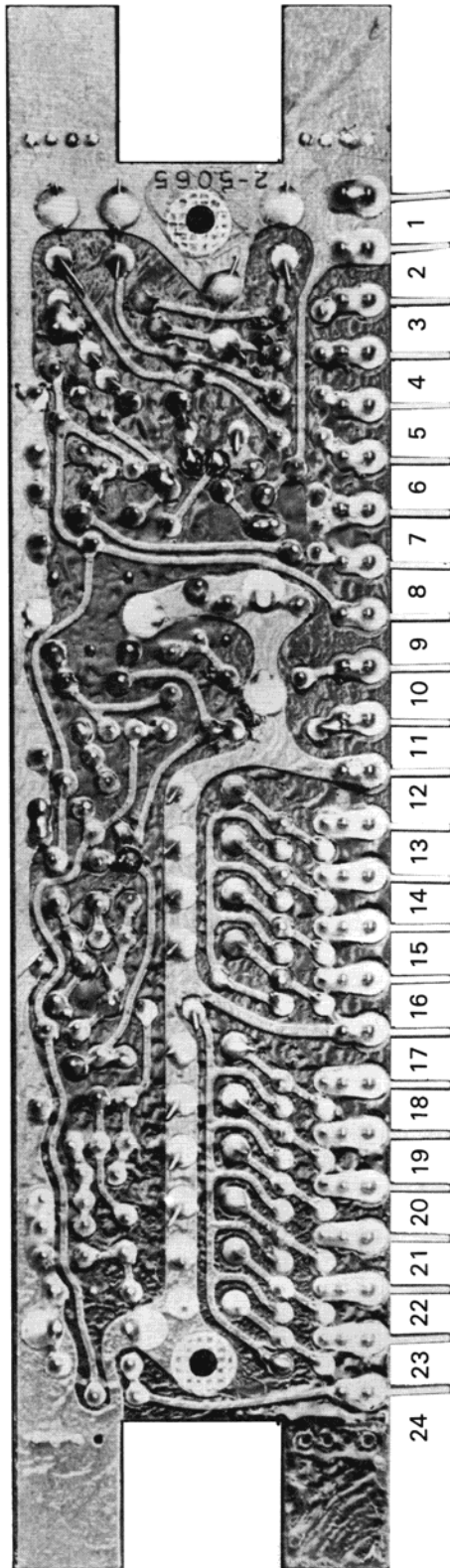

# 1-580 PARTS LIST

## Crystal Oscillator Parts List

Ref. #	Description	Part #
<b>Semiconductors</b>		
Q1-Q4	2SC710 Transistor	
D1-D14	MC301 Diode	
D15	ITT301 Varactor	
<b>Coils — Inductors</b>		
L1	Choke (LF4-100K) .....	2-0074
L2	Choke (15uH) .....	2-0170
T1	r.f. Transformer (819-50L/23579) .....	2-0175
T2	r.f. Transformer (819-50L/23579) .....	2-0175
T3	r.f. Transformer (820-50L/23578) .....	2-0176
<b>Capacitors</b>		
C1	15pF	
C2	30pF	
C3	15pF	
C4	51pF	
C5	.001 $\mu$ F	
C6	39pF	
C7	300pF	
C8	15pF	
C9	39pF	
C10	100pF	
C11	.001 $\mu$ F	
C12	120pF	
C13	120pF	
C14	3pF	
C15	.001 $\mu$ F	
C16	.001 $\mu$ F	
C17	.001 $\mu$ F	
C18	300pF	
C19	10pF	
C20	51pF	
C21	.001 $\mu$ F	
<b>Resistors (All 1/4w 5%)</b>		
R1-R10	5.1K	
R11	5.1K	
R12	2K	
R13	5.1K	
R14	10K	
R15	15K	
R16	5.1K	
R17	1K	
R19	10K	
R20	510 $\Omega$	
R21,22,24	5.1K	
R23	2.7K	
R25	5.1K	
R26,27,28,29	51K	
R30	1K	
<b>Crystals (in MHz)</b>		
10.140	10.595	37.600
10.160	10.615	37.650
10.170	10.625	37.700
10.180	10.635	37.750
		37.800
		37.850

## CRYSTAL FREQUENCY CHART

(A) Group 6 pcs.

X<sup>1</sup> 37.60 MHz  
 X<sup>2</sup> 37.65 MHz  
 X<sup>3</sup> 37.70 MHz  
 X<sup>4</sup> 37.75 MHz  
 X<sup>5</sup> 37.80 MHz  
 X<sup>6</sup> 37.85 MHz

(B) Group 4 pcs.  
 (Transmitting)

X<sup>7</sup> 10.635 MHz  
 X<sup>8</sup> 10.625 MHz  
 X<sup>9</sup> 10.615 MHz  
 X<sup>10</sup> 10.595 MHz

(C) Group 4 pcs.  
 (Receiving)

X<sup>11</sup> 10.18 MHz  
 X<sup>12</sup> 10.17 MHz  
 X<sup>13</sup> 10.16 MHz  
 X<sup>14</sup> 10.14 MHz

CHANNEL	FREQUENCY (MHz)	Combination (Transmit)	Combination (Receive)
1.	26.965	X <sup>1</sup> - X <sup>7</sup>	X <sup>1</sup> - X <sup>11</sup>
2.	26.975	X <sup>1</sup> - X <sup>8</sup>	X <sup>1</sup> - X <sup>12</sup>
3.	26.985	X <sup>1</sup> - X <sup>9</sup>	X <sup>4</sup> - X <sup>13</sup>
4.	27.005	X <sup>1</sup> - X <sup>10</sup>	X <sup>1</sup> - X <sup>14</sup>
5.	27.015	X <sup>2</sup> - X <sup>7</sup>	X <sup>2</sup> - X <sup>11</sup>
6.	27.025	X <sup>2</sup> - X <sup>8</sup>	X <sup>2</sup> - X <sup>12</sup>
7.	27.035	X <sup>2</sup> - X <sup>9</sup>	X <sup>2</sup> - X <sup>13</sup>
8.	27.055	X <sup>2</sup> - X <sup>10</sup>	X <sup>2</sup> - X <sup>14</sup>
9.	27.065	X <sup>3</sup> - X <sup>7</sup>	X <sup>3</sup> - X <sup>11</sup>
10.	27.075	X <sup>3</sup> - X <sup>8</sup>	X <sup>3</sup> - X <sup>12</sup>
11.	27.085	X <sup>3</sup> - X <sup>9</sup>	X <sup>3</sup> - X <sup>13</sup>
12.	27.105	X <sup>3</sup> - X <sup>10</sup>	X <sup>3</sup> - X <sup>14</sup>
13.	27.115	X <sup>4</sup> - X <sup>7</sup>	X <sup>4</sup> - X <sup>11</sup>
14.	27.125	X <sup>4</sup> - X <sup>8</sup>	X <sup>4</sup> - X <sup>12</sup>
15.	27.135	X <sup>4</sup> - X <sup>9</sup>	X <sup>4</sup> - X <sup>13</sup>
16.	27.155	X <sup>4</sup> - X <sup>10</sup>	X <sup>4</sup> - X <sup>14</sup>
17.	27.165	X <sup>5</sup> - X <sup>7</sup>	X <sup>5</sup> - X <sup>11</sup>
18.	27.175	X <sup>5</sup> - X <sup>8</sup>	X <sup>5</sup> - X <sup>12</sup>
19.	27.185	X <sup>5</sup> - X <sup>9</sup>	X <sup>5</sup> - X <sup>13</sup>
20.	27.205	X <sup>5</sup> - X <sup>10</sup>	X <sup>5</sup> - X <sup>14</sup>
21.	27.215	X <sup>6</sup> - X <sup>7</sup>	X <sup>6</sup> - X <sup>11</sup>
22.	27.225	X <sup>6</sup> - X <sup>8</sup>	X <sup>6</sup> - X <sup>12</sup>
23.	27.255	X <sup>6</sup> - X <sup>10</sup>	X <sup>6</sup> - X <sup>14</sup>

# WIRING DIAGRAM 1-580 MAIN CHASSIS

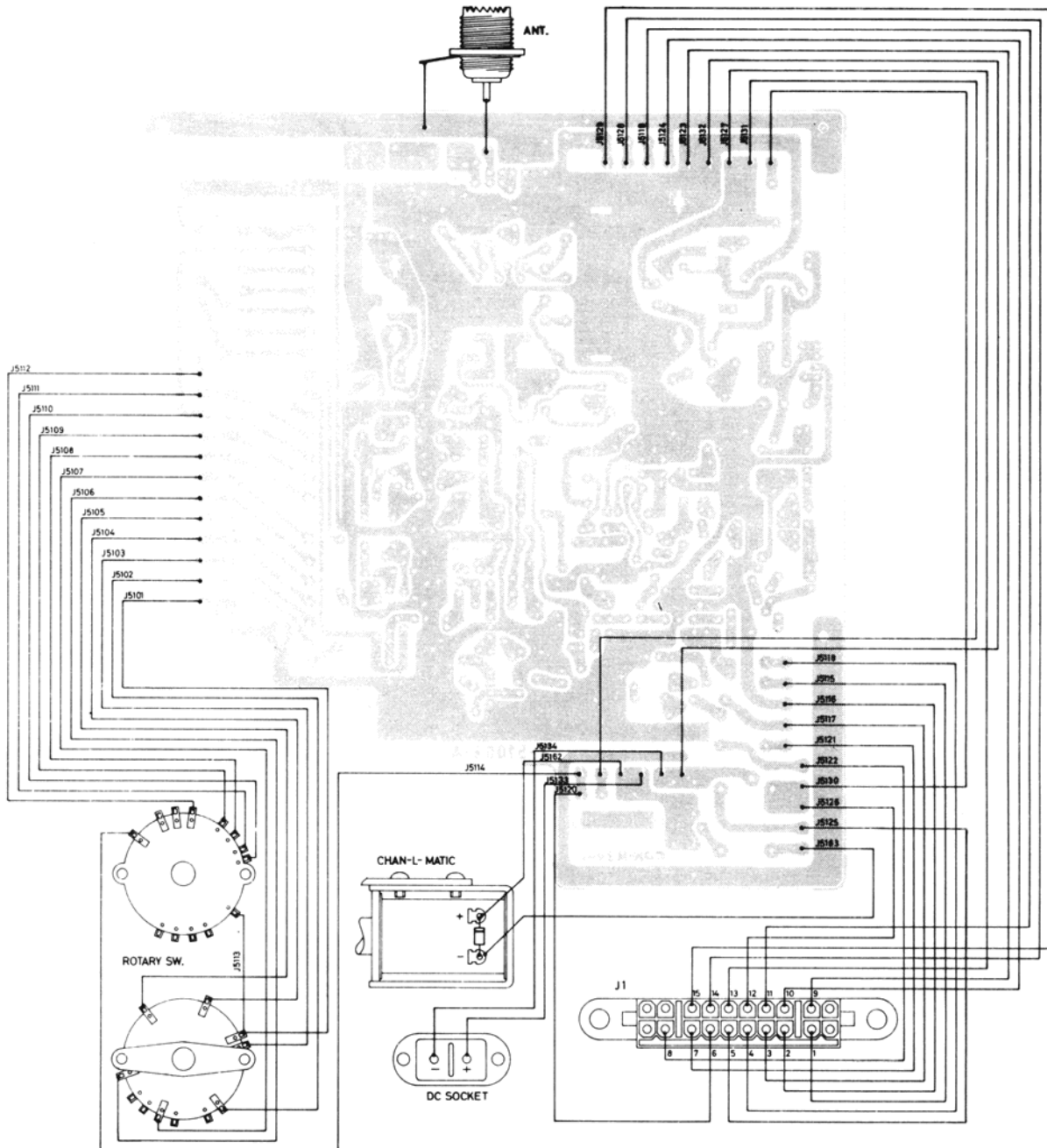

# WIRING DIAGRAM 1-580 CONTROL HEAD

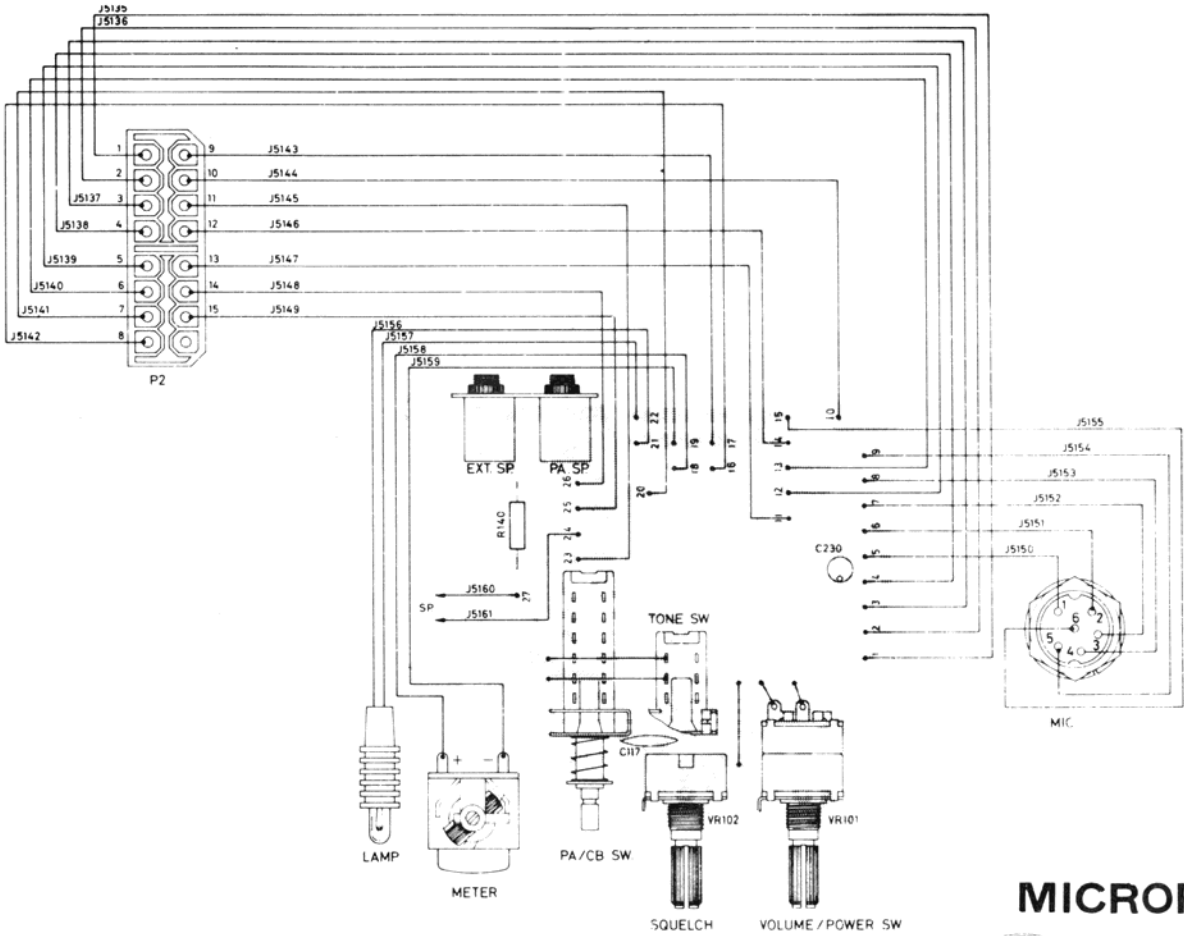

## MICROPHONE

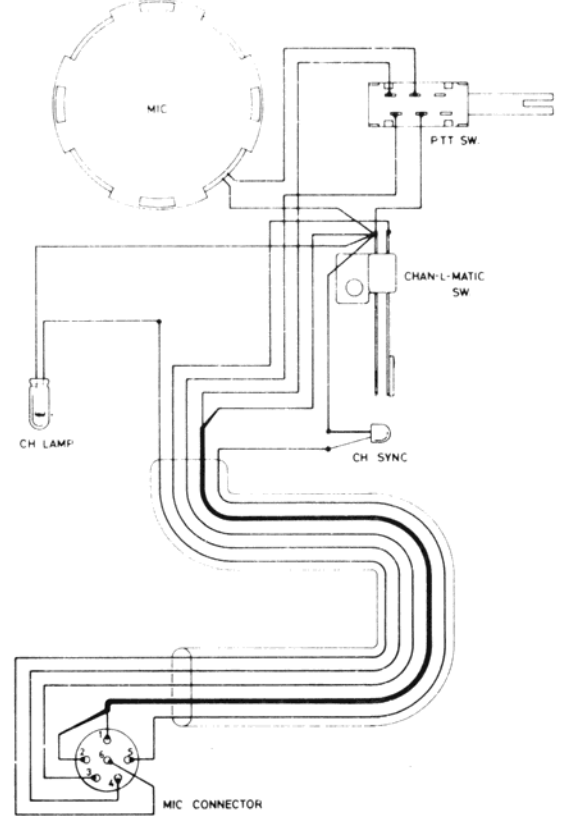

# I-580 Alignment Instruction

## RECEIVER

- A. Inject at the ant. jack a 27.115 MHz signal ( $\pm .002\%$  ;30% modulation at 1 KHz).
- B. Connect an audio voltmeter and oscilloscope across on 8 ohm load and plug into external speaker jack.

Test Equipment	Test Point	Adjust	Remarks
1. RF signal generator (low range to avoid audio saturation)	Inject at ant. jack	channel sel to 13	
		T-101, T-102, T-103	Max. output with vol. control at max, squelch control at min. output should be more than 500mw (2.0v /8 ohm) with gen. voltage at 1 uV; S & N/N =more than 10dB on all channels

## AGC RESPONSE

Set the output voltage of a signal generator at 50000 uV and adjust the volume control so that the voltmeter output is 500 mW (2.0v/8 ohms). Then, lower the output voltage of the generator so that the voltmeter output is 10dB down. The output voltage of the signal generator should be under 5 uV at this time.

## SQUELCH

Set squelch control to maximum. Set signal generator to 500 uV, and adjust VR103 so that squelch opens at 500 uV signal level.

## S-METER ADJUSTMENT

- A. Set RF signal generator to 100 uV. Adjust VR104 until the pointer of the meter remains approximately at one-quarter from the left in the red zone.

## AUDIO POWER CHECK

With a generator output of 1 mV and squelch control at minimum, audio output should be more than 4W (5.7v/8 ohm) at maximum position of volume control.

## TRANSMITTER

- A. Power Supply – 13.8VDC.  
B. Use a suitable power meter, non-inductive dummy load and oscilloscope connected to antenna jack.

Test Equipment	Test Point	Adjust	Remarks
1. Power Meter	antenna jack	T-201, T-202, L-203, L-204	Adjust for maximum output power.
2. Freq. Counter	across dummy load	————	Check all channels $\pm$ 800 Hz
3. A.F. Oscillator with AF voltmeter in shunt (1 KHz 10mV)	Inject at mic input	VR-201	–90% modulation on oscilloscope
		————	Reduce AF oscillator output to 5mV; modulation $\geq$ 50%

- C. With 0% modulation and carrier power 3.5 to 4 Watts, adjust VR202 until the pointer of the meter remains approximately at one-quarter from the left in the red zone.

# SPECIFICATIONS

1-580

## GENERAL

1. Semiconductors : 17 Transistors, 14 Diodes, 1 IC and 1 LED
2. Frequency Range : 26.965 MHz – 27.255 MHz
3. Mode of Operation : AM
4. Controls/Features
  - a. Control Box : Off-On-Volume Control  
: Squelch Control  
: Hi-Lo Tone Switch  
: PA-CB Switch  
: S-RF Meter  
: Microphone Connector  
: PA Speaker Jack  
: EXT. Speaker Jack  
: Control Cable
  - b. Microphone : Dynamic 500 ohms  
: Channel Selector Pushbutton  
: Push-To-Talk Switch  
: Channel Window  
: Channel Synchronous Indicator Lamp  
: Extension Cord
  - c. Electronic Box : DC Power Connector  
: Control Cable Connector  
: Antenna Connector
5. Speaker : 2-1/2 inchs 8 ohms
6. Power Supply : 13.8VDC Positive or Negative Ground
7. Dimensions/Weight (Approx.)

	Control Box	Electrical Box	Microphone
Width :	4-1/8	6-9/16	2-1/2
Height:	1-5/16	2-1/8	3-7/8
Depth :	4-1/16	8-1/8	2
Weight:	1 Lbs. 12 Ozs.	4 Lbs. 3 Ozs.	9 Ozs.

## RECEIVER

1. Sensitivity at S/N 10 db : 0.5 uV typical
2. Adjacent Channel rejection : More than 80 db
3. AGC Figure of Range : 80 db
4. Squelch Range : 0.5 uV – 500 uV
5. Audio Power Output : 4 watts
6. Distortion at Input 100 uV : 6%
7. Audio Frequency Response : 400 – 2,000 Hz
8. Spurious Response : More than 45 db spurious signal is required to produce the same amount of audio output as a desired receive signal.
9. IF Frequency : 1st . . . . . 10.595 . . . . . 10.635 MHz  
: 2nd . . . . . 455 KHz
10. Current Drain no audio : 250 mA

## TRANSMITTER

1. RF Power Output : 4 watts
2. Modulation Capability : Up to 98%
3. Harmonic Suppression : More than 50 db
4. Current Drain : 1,200 mA

# 1-580 PARTS LIST

REF. #	DESCRIPTION	PART #
	<b>SEMICONDUCTORS</b>	
Q 101	2SC674 transistor	Where Part Numbers are not given, order by MODEL and DESCRIPTION
Q 102	2SC710 transistor	
Q 103	2SC711 transistor	
Q 104	2SC711 transistor	
Q 105	2SC711 transistor	
Q 106	2SA562 transistor	
Q 107	2SC372 transistor	
Q 108	2SC372 transistor	
Q 109	2SC372 transistor	
Q 201	2SC710 transistor	
Q 202	2SC1018 transistor	
Q 203	2SC756 transistor	
Q 204	2SB561 transistor	
Q 205	2SC372 transistor	
Q 301	2SC735 transistor	
Q 302	TA7062P I.C.	
Q 303, 304	2SD330 transistor	
D 101	10D-1 diode	
D 102	1S188 diode	
D 103	1S188 diode	
D 106	1S2075K diode	
D 107	HV-46 diode	
D 108	1S188 diode	
D 201	1S188 diode	
D 202	10D-1 diode	
D 203	10D-1 diode	
D 301	SV-9 diode	
D 302	10D-1 diode	
D 303	U05-B diode	
D 304	EQB01-09 diode (zener) L.E.D. (channel sync)	
	<b>COILS — INDUCTORS</b>	
L 101	r.f. coil (49169)	
L 201	r.f. coil (49170)	
L 202	r.f. coil (4056)	
L 203	r.f. coil (49168)	
L 204	r.f. coil (49166)	
L 301	coil (LF5-223K)	
T 101	r.f. transformer (15089)	
T 102	r.f. transformer (15061)	
T 103	r.f. transformer (15090)	
T 201	r.f. transformer (20105)	
T 202	r.f. transformer (49167)	
T 1	modulation transformer (20015)	
T 2	driver transformer (1001)	
T 3	choke transformer (1002)	
	<b>CASE PARTS</b>	
	control head, case top	
	control head, case bottom	
	mounting bracket	
	mounting bolts	
	control head, front panel	
	control head decoration plate	
	volume knob	
	TONE push knob	
	main chassis case top	
	main chassis case bottom	

1-580 Continued

REF. #	DESCRIPTION	PART #
	<b>CONTROLS</b>	
VR101	volume control (10K)	
VR102	squelch control (10K)	
VR103	semi-fixed resistor (5K)	
BR104	semi-fixed resistor (20K)	S2 tone switch
VR201	semi-fixed resistor (10K)	S3 PA-CB switch
VR202	semi-fixed resistor (50K)	S4 channel switch
CT201	variable capacitor (20pF)	
	<b>MISCELLANEOUS</b>	
	S/RF meter	
	ext. spkr./PA jack	
	mic jack	
	antenna jack	
RL 1	relay	
RL2	relay	
	channel switch solenoid	
	channel lamp	
	microphone (complete)	
	crystal oscillator unit	
	cable harness	
	speaker	
F101	10.7 MHz filter (SFE-10.7 MAS)	
F102, 103	455 KHz i.f. filter (CFU-455H)	
	<b>RESISTORS — CAPACITORS</b>	
	Refer to schematic for specific values	